

Modular Cooking Range Line EVO700 Two Wells Freestanding Gas Fryer 15 liter

ITEM # _____

MODEL # _____

NAME # _____

SIS # _____

AIA # _____



372071 (Z7FRGH2GF0)

15+15-lt gas fryer with 2 "V"
shape wells (external burners)
and 2 baskets - free standing

Short Form Specification

Item No. _____

To be installed on height adjustable feet in stainless steel. Four high efficiency 7 kW burners in stainless steel. Suitable for natural gas or LPG. Deep drawn V-shaped well. Oil drains through a tap into a container under the well. Exterior panels in stainless steel with Scotch Brite finish. One piece pressed work top in 1.5 mm thick stainless steel. Right-angled side edges to allow flush-fitting junction between units.

Main Features

- Unit to be mounted on 50mm height adjustable feet in stainless steel.
- Deep drawn V-Shaped wells.
- Four high efficiency 7 kW burners in stainless steel with flame failure device attached to the outside of the well.
- Thermostatic regulation of oil temperature up to a maximum of 185 °C.
- Flame failure device on each burner.
- Overheat protection thermostat as standard on all units.
- Oil drains through a tap into a drainage container positioned under the well.
- All major compartments located in front of unit for ease of maintenance.
- Piezo spark ignition for added safety.
- Gas appliance supplied for use with natural or LPG gas, conversion jets supplied as standard.
- IPx4 water protection.
- Optional portable oil quality monitoring tool (code 9B8081) for efficient oil management.

Construction

- Interior of well with rounded corners for ease of cleaning.
- All exterior panels in Stainless Steel with Scotch Brite finishing.
- One piece pressed 1.5 mm work top in Stainless steel.
- Model has right-angled side edges to allow flush fitting joints between units, eliminating gaps and possible dirt traps.

APPROVAL: _____

Included Accessories

- 2 of Door for open base cupboard PNC 206342
- 2 of Basket for 14 and 15lt fryers PNC 921691

Optional Accessories

- Junction sealing kit PNC 206086
- Draught diverter, 150 mm diameter PNC 206132
- Matching ring for flue condenser, 150 mm diameter PNC 206133
- 4 wheels, 2 swivelling with brake (EVO700/900). It is mandatory to install with base supports for feet/wheels. PNC 206135
- Flanged feet kit PNC 206136
- Frontal kicking strip for concrete installation, 800 mm PNC 206148
- Frontal kicking strip for concrete installation, 1000 mm PNC 206150
- Frontal kicking strip for concrete installation, 1200 mm PNC 206151
- Frontal kicking strip for concrete installation, 1600 mm PNC 206152
- Frontal handrail 800 mm PNC 206167
- Frontal kicking strip, 800 mm PNC 206176
- Frontal kicking strip, 1000 mm PNC 206177
- Frontal kicking strip, 1200 mm PNC 206178
- Frontal kicking strip, 1600 mm PNC 206179
- Large handrail (portioning shelf) 800 mm PNC 206186
- Frontal handrail 1200 mm PNC 206191
- Frontal handrail 1600 mm PNC 206192
- 4 feet for concrete installation (not for 900 line freestanding grill) PNC 206210
- Sediment tray for 15lt fryers PNC 206235
- Right and left side handrails PNC 206240
- Flue condenser for 1 module, 150 mm diameter PNC 206246
- Pair of side kicking strips PNC 206249
- Pair of side kicking strips (concrete installation) PNC 206265
- Oil drain pipe for 15lt free standing fryer PNC 206301
- Chimney upstand, 800 mm PNC 206304
- 2 side covering panels, height 700 mm, depth 700 mm PNC 206319
- Door for open base cupboard PNC 206342
- Base support for feet or wheels - 800mm (EVO700/900) PNC 206367
- Base support for feet or wheels - 1200mm (EVO700/EVO900) PNC 206368
- Base support for feet or wheels - 1600mm (EVO700/900) PNC 206369
- Rear paneling - 800mm (EVO700/900) PNC 206374
- Rear paneling - 1000mm (EVO700/900) PNC 206375
- Rear paneling - 1200mm (EVO700/900) PNC 206376
- Chimney grid net, 400mm PNC 206400
- Basket for 14 and 15lt fryers PNC 921691
- 2 half size baskets for 12, 14 and 15lt fryers PNC 921692
- Filter for fryer oil collection basin for 7lt, 14lt, 15lt free standing fryers PNC 921693

- Unclogging rod for 15lt fryers drainage pipe PNC 921695
- Deflector for floured products for the 15lt fryer PNC 921696
- Pressure regulator for gas units PNC 927225

Modular Cooking Range Line EVO700 Two Wells Freestanding Gas Fryer 15 liter

Front

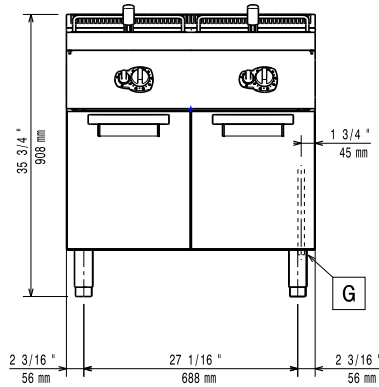

Side

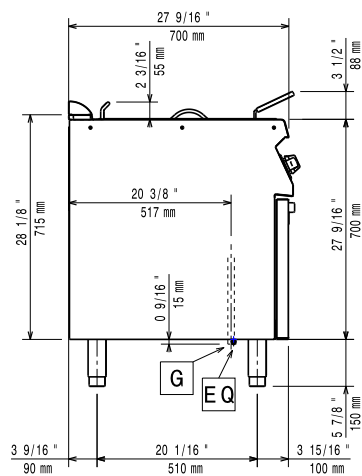

EQ = Equipotential screw
G = Gas connection

Top

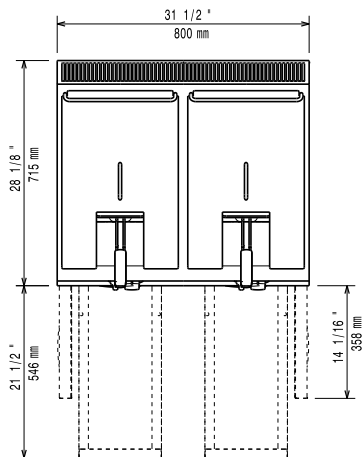

Gas

Gas Power:	372071 (Z7FRGH2GF0)	28 kW
Standard gas delivery:		Natural Gas G20 (20mbar)
Gas Type Option:		LPG; Natural Gas
Gas Inlet:		1/2"

Key Information:

Usable well dimensions (width):	240 mm
Usable well dimensions (height):	505 mm
Usable well dimensions (depth):	380 mm
Well capacity:	13 lt MIN; 15 lt MAX
Thermostat Range:	105 °C MIN; 185 °C MAX
Net weight:	85 kg
Shipping weight:	97 kg
Shipping height:	1130 mm
Shipping width:	820 mm
Shipping depth:	860 mm
Shipping volume:	0.8 m ³

If appliance is set up or next to or against temperature sensitive furniture or similar, a safety gap of approximately 150 mm should be maintained or some form of heat insulation fitted.

Certification group: N7FG