

## Modular Cooking Range Line EVO900 Two Wells Electric Fryer 23 liter

ITEM # \_\_\_\_\_

MODEL # \_\_\_\_\_

NAME # \_\_\_\_\_

SIS # \_\_\_\_\_

AIA # \_\_\_\_\_



**392338 (Z9KKGDBAMEA)** 23+23-lt electric fryer with 2 "V" shaped wells (external heating elements) and 4 half size baskets - free standing

**392385 (Z9KKGDBAMEA)** 23+23-lt electric fryer with 2 "V" shaped wells (external heating elements) and 4 half size baskets - free standing

### Short Form Specification

Item No. \_\_\_\_\_

High efficiency external infrared heating elements (36kW) with innovative deflectors attached to the outside of the wells. Deep drawn V-Shaped wells. Oil drains through a tap into a container positioned under the wells. Height adjustable feet in stainless steel. Exterior panels in stainless steel. Worktop in 20/10, stainless steel. Right-angled side edges eliminate gaps and possible dirt traps between units.

### Main Features

- Deep drawn V-Shaped wells.
- Interior of wells with seamlessly laser-welded corners for ease of cleaning.
- External infrared heating elements with innovative deflectors applied to the well for ease of cleaning of the internal well and safe operations.
- Thermostatic regulation of oil temperature up to a maximum of 185 °C.
- Overheat protection thermostat as standard on all units.
- All major compartments located in front of unit for ease of maintenance.
- IPX5 water resistance certification.
- The special design of the control panel offers a better guarantee against oil infiltration. (only for 392338)
- Supplied as standard with 4 half size baskets and 1 right and left side doors for cupboard.
- The special design of the control knob system guarantees against water infiltration. (only for 392385)
- Optional portable oil quality monitoring tool (code 9B8081) for efficient oil management.

### Construction

- All exterior panels in Stainless Steel with Scotch Brite finishing.
- Model has right-angled side edges to allow flush fitting joints between units, eliminating gaps and possible dirt traps.
- Unit is 900mm deep to give a larger working surface area.
- Unit delivered with four 50 mm legs in stainless steel as standard.

APPROVAL: \_\_\_\_\_

### Included Accessories

- 2 of Door for open base cupboard (only for 392385) PNC 206342
- 2 of DOOR FOR OPEN BASE CUPBOARD (only for 392338) PNC 206350
- 2 of 2 half size baskets for 18/23lt well fryers PNC 927223

### Optional Accessories

- Stainless steel oil filter for 23 litres fryer to remove particles of grease and food residuals) - EVO900 PNC 200086
- Junction sealing kit PNC 206086
- 4 wheels, 2 swivelling with brake (EVO700/900). It is mandatory to install with base supports for feet/wheels. PNC 206135
- Flanged feet kit PNC 206136
- Frontal kicking strip for concrete installation, 800 mm (only for 392385) PNC 206148
- Frontal kicking strip for concrete installation, 1000 mm (only for 392385) PNC 206150
- Frontal kicking strip for concrete installation, 1200 mm (only for 392385) PNC 206151
- Frontal kicking strip for concrete installation, 1600 mm (only for 392385) PNC 206152
- Side handrail for right/left hand (only for 392385) PNC 206165
- Frontal handrail 800 mm (only for 392385) PNC 206167
- Pair of side kicking strips PNC 206180
- 2 panels for service duct (single installation) (only for 392385) PNC 206181
- Large handrail (portioning shelf) 800 mm (only for 392385) PNC 206186
- Frontal handrail 1200 mm (only for 392385) PNC 206191
- Frontal handrail 1600 mm (only for 392385) PNC 206192
- Hygienic lid for 23lt fryers PNC 206201
- 2 panels for service duct (back to back installation) (only for 392385) PNC 206202
- Frontal kicking strip for 23lt fryers in two parts PNC 206203
- Extension pipe for oil drainage for 15lt, 18lt, 23lt fryers PNC 206209
- 4 feet for concrete installation (not for 900 line freestanding grill) (only for 392385) PNC 206210
- Chimney upstand, 800 mm PNC 206304
- 2 side covering panels, height 700 mm, depth 900 mm (only for 392385) PNC 206335
- Door for open base cupboard (only for 392385) PNC 206342
- Base support for feet/wheels (lateral) for 23lt fryers and pastacookers and refrigerated bases (900) PNC 206372
- Rear paneling - 800mm (EVO700/900) (only for 392385) PNC 206374
- Rear paneling - 1000mm (EVO700/900) (only for 392385) PNC 206375
- Rear paneling - 1200mm (EVO700/900) (only for 392385) PNC 206376
- Chimney grid net, 400mm PNC 206400

- Sediment collection tray for 23 litres fryer (to be put in the well) - EVO900 PNC 921023
- 2 half baskets for 18/23lt fryers with front hook PNC 927200
- 1 full basket for 18/23lt fryers with front hook PNC 927201
- 2 half size baskets for 18/23lt well fryers PNC 927223
- 1 full size basket for 18/23lt well fryers PNC 927226
- Unclogging rod for 23lt fryers drainage pipe PNC 927227
- Deflector for floured products for the 23lt fryer PNC 960645

**Front**

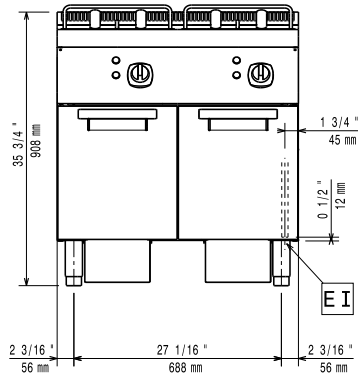

**Side**

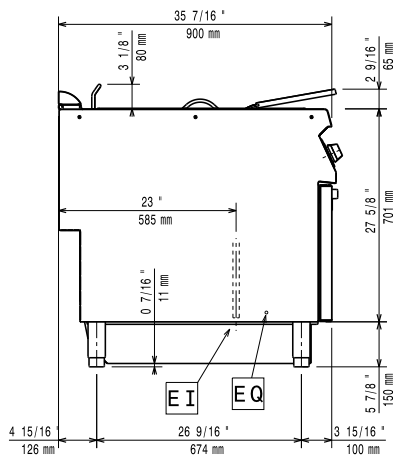

EI = Electrical inlet (power)  
EQ = Equipotential screw

**Top**

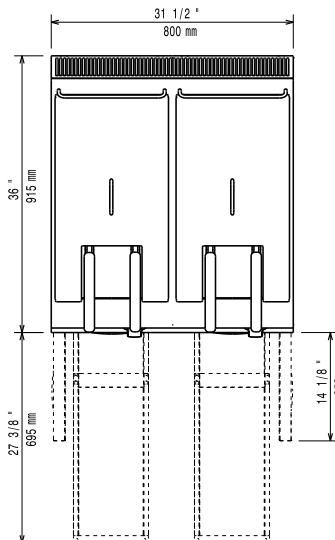

**Electric**

**Supply voltage:**

<b>392338 (Z9KKGDBAMEA)</b>	380-400 V/3N ph/50/60 Hz
<b>392385 (Z9KKGOBAMEA)</b>	415-430 V/3N ph/50/60 Hz

**Total Watts:**

<b>392338 (Z9KKGDBAMEA)</b>	36 kW
<b>392385 (Z9KKGOBAMEA)</b>	34.4 kW

**Key Information:**

<b>Usable well dimensions (width):</b>	340 mm
<b>Usable well dimensions (height):</b>	575 mm
<b>Usable well dimensions (depth):</b>	400 mm
<b>Well capacity:</b>	21 lt MIN; 23 lt MAX

**Performance\*:**

<b>392338 (Z9KKGDBAMEA)</b>	75 kg\hr
<b>392385 (Z9KKGOBAMEA)</b>	70.8 kg\hr

**Thermostat Range:** 105 °C MIN; 185 °C MAX

**Net weight:** 115 kg

**Shipping weight:**

<b>392338 (Z9KKGDBAMEA)</b>	125 kg
<b>392385 (Z9KKGOBAMEA)</b>	116 kg

**Shipping height:**

<b>392338 (Z9KKGDBAMEA)</b>	1080 mm
<b>392385 (Z9KKGOBAMEA)</b>	1090 mm

**Shipping width:** 1020 mm

**Shipping depth:** 860 mm

**Shipping volume:**

<b>392338 (Z9KKGDBAMEA)</b>	0.95 m <sup>3</sup>
<b>392385 (Z9KKGOBAMEA)</b>	0.96 m <sup>3</sup>

If appliance is set up or next to or against temperature sensitive furniture or similar, a safety gap of approximately 150 mm should be maintained or some form of heat insulation fitted.

**\*Based on:** ASTM F1361-Deep fat fryers

**Certification group:** EFE92M23